



SAH
Stahlwerk Annahütte

SAS Zugstabsysteme

SAS tie rods

SAS SYSTEMS



Hauptanwendungen von SAS Zugstabsysteme

application of SAS tie rods



Hauptanwendungsgebiete von Zugbändern sind Verspannungen von Fangedämmen, Spundwandkonstruktionen sowie Rückverankerungen von Baugrubenwänden.

Main applications of tie rods are bracing for embankments, sheet pile structures, as well as tie back retaining walls.

Vorteile des SAS Gewindestahls für Zugstabsysteme

advantages of SAS thread bars for tie rods

- Endlos schraubbares, robustes Grobgewinde mit Selbstreinigungseffekt
- SAS Gewindestahl kann an jeder beliebigen Stelle abgeschnitten und durch Muffen gekoppelt werden
- Stahllängen werden individuell zugeschnitten
- Verschiedene Gewindestahldurchmesser in unterschiedlichen Stahlgüten für diverse Anwendungen erhältlich
- Sonderausführungen möglich (z.B. Verzinken von Stab und Zubehör)
- Unterschiedliche Korrosionsschutzsysteme ausführbar
- *screwable, coarse thread ribs over full length of the bar with self-cleaning thread effect*
- *cutting or extension with couplers possible at any position of the SAS thread bar*
- *individual customized lengths are available*
- *various thread bar diameters in different steel grades are available for many applications*
- *availability of special treated bars and accessories (f.e. hot-dip galvanized)*
- *different possibilities of corrosion protection*

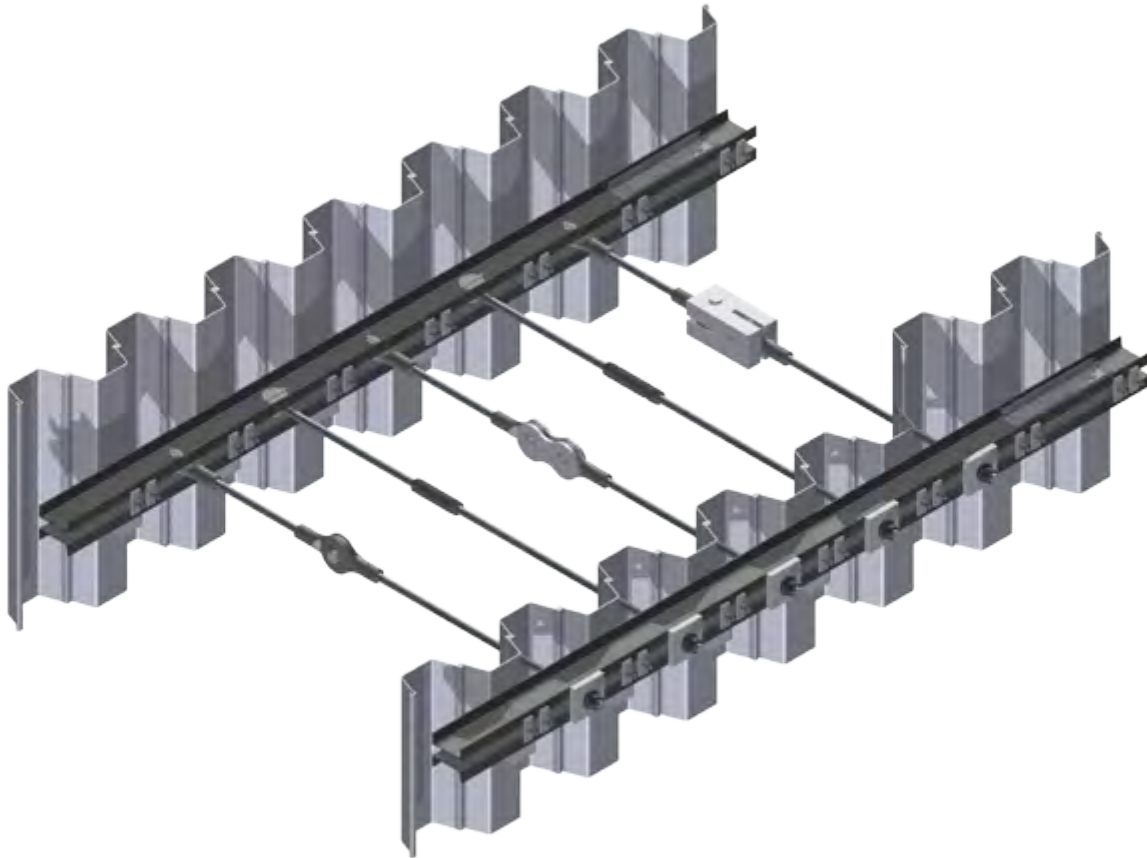

Korrosionsschutz













corrosion protection

Ein wichtiger Aspekt im Hinblick auf den dauerhaften Einsatz von Zugbändern ist der Korrosionsschutz. Für die SAS Gewindestahlsysteme sind verschiedene Korrosionsschutzsysteme ausführbar:

- Feuerverzinkung
- Abrostrate
- Epoxybeschichtung
- Schrumpfschlauch
- Doppelter Korrosionsschutz durch Zementsteinüberdeckung und Hüllrohr

An important aspect in the long term durability of any tie rods installation is corrosion protection. Different possibilities of corrosion protection are achievable for the SAS thread bar system:

- *hot-dipped galvanizing*
- *sacrificial corrosion*
- *epoxy coating*
- *heat shrink sleeve*
- *double corrosion protection with cement grout and sheathing*

Streckgrenze / Zugfestigkeit <i>yield stress / ultimate stress</i> Anwendungsbereiche / <i>areas of application</i>		Nenn- \varnothing <i>nom.-\varnothing</i>	Strecklast <i>yield load</i>	Bruchlast <i>ultimate load</i>	Fläche <i>cross section area</i>	Gewicht <i>weight</i>	Dehnung <i>elongation</i>				
		[mm]	[kN]	[kN]	[mm ²]	[m/to]	[kg/m]	A _{gt} [%]	A ₁₀ [%]		
SAS 500 / 550 - grade 75											
 Bewehrungstechnik / <i>reinforcing systems</i>		12	57	62	113	1123,6	0,89	6	10		
		14	77	85	154	826,4	1,21				
		16	100	110	201	632,9	1,58				
		20	160	175	314	404,9	2,47				
		25	245	270	491	259,7	3,85				
		28	310	340	616	207,0	4,83				
 Geotechnik / <i>geotechnical systems</i>		32	405	440	804	158,5	6,31				
		36	510	560	1020	125,2	7,99				
		40	630	690	1260	101,3	9,87				
		43	726	799	1452	87,7	11,40				
		50	980	1080	1960	64,9	15,40				
SAS 555 / 700 - grade 80		57,5	1441	1818	2597	49,1	20,38	5	10		
SAS 555 / 700 - grade 80		63,5	1760	2215	3167	40,2	24,86	5	---		
SAS 500 / 550 - grade 75		75	2209	2430	4418	28,8	34,68	5	---		
<i>Alternativ SAS 550 erhältlich / alternative SAS 550 grade 75 available</i>											
SAS 450 / 700 - grade 60											
 Bergbau / <i>mining</i>		16	93	145	207	617,3	1,62	(A ₅) 15			
		25	220	345	491	259,7	3,85	(A ₅) 20			
SAS 650 / 800 - grade 90											
 Bergbau / <i>mining</i>		22	247	304	380	335,6	2,98	(A ₅) 18			
		25	319	393	491	259,7	3,85				
		28	400	493	616	207,0	4,83				
		30	460	565	707	180,2	5,55				
SAS 670 / 800 - grade 97											
 Geotechnik / <i>geotechnical systems</i>		18	170	204	254	500,0	2,00	5			
		22	255	304	380	335,6	2,98				
		25	329	393	491	259,7	3,85				
		28	413	493	616	207,0	4,83				
 Ankertechnik / <i>tunneling & mining</i>		30	474	565	707	180,2	5,55				
		35	645	770	962	132,5	7,55				
		43	973	1162	1452	87,7	11,40				
		50	1315	1570	1963	64,9	15,40				
 Hochfeste Bewehrung / <i>high-strength reinforcement</i>		57,5	1740	2077	2597	49,1	20,38			---	
		63,5	2122	2534	3167	40,2	24,86			---	
		75	2960	3535	4418	28,8	34,68	---			
SAS 950 / 1050 - grade 150											
 Spanntechnik / <i>post-tensioning systems</i>		18	230	255	241	510,2	1,96	5			
		26,5	525	580	551	223,2	4,48				
		32	760	845	804	153,1	6,53				
		36	960	1070	1020	120,9	8,27				
 Geotechnik / <i>geotechnical systems</i>		40	1190	1320	1257	97,9	10,21				
		47	1650	1820	1735	70,9	14,10				
SAS 835 / 1035 - grade 150											
 Geotechnik / <i>geotechnical systems</i>		57	2155	2671	2581	47,7	20,95			4	
		65	2780	3447	3331	36,9	27,10				
		75	3690	4572	4418	27,9	35,90				
SAS 900 / 1100 FA - grade 160 FA schweißbar / weldable											
 Schalungstechnik / <i>formwork ties</i>		15	159	195	177	694,4	1,44	3			
		20	283	345	314	390,6	2,56				
		26,5	495	606	551	223,2	4,48				
SAS 900 / 1050 FC - grade 150 FC											
 Schalungstechnik / <i>formwork ties</i>		15	159	186	177	694,4	1,44	3			
		20	283	330	314	390,6	2,56				
SAS 950 / 1050 E - grade 150		26,5	525	580	551	223,2	4,48	5	7		
SAS 750 / 875 FS - kaltgerollt / cold rolled - grade 120 FS schweißbar / weldable											
 Schalungstechnik / <i>formwork ties</i>		12,5	90	120	132,5	961,5	1,04	2			
		15	142	165	189	675,7	1,48				
		20	245	285	326	390,6	2,56				

Zubehör für alle Abmessungen und Anwendungen lieferbar / *accessories for all dimensions and applications available*